

Assignment 5: Priority Queue

Assignment idea, handout introduction, and binary heap specifications come from Julie Zelenski. Everything else, including the binomial heap implementation and rest of the handout, comes from Jerry.

It's finally time for you to implement a class of your own. That class is a priority queue, and it's a variation on the standard queue described in lecture and in the course textbook.

The standard queue is a collection of elements managed in a first-in, first-out manner. The first element added to the collection is always the first element extracted; the second is second; so on and so on. In some cases, however, a FIFO strategy may be too simplistic for the problem being solved. A hospital emergency room, for example, needs to schedule patients according to priority. A patient who arrives with a more serious problem should pre-empt others even if they have been waiting longer. This is a *priority queue*, where elements are added to the queue in arbitrary order, but when time comes to extract the next element, it is the highest priority element in the queue that is removed.

The main focus of this assignment is to implement a priority queue class in several different ways. You'll have a chance to experiment with arrays and linked structures, and in doing so you'll master the pointer gymnastics that go along with it.

Monday, November 4th at 11:59pm

The PQueue Interface

The priority queue will be a collection of strings. Lexicographically smaller strings should be considered **higher** priority than lexicographically larger ones, so that "**ping**" is higher priority than "**pong**", regardless of insertion order.

Here are the methods that make up the **public** interface of all priority queues:

```
class PQueue {
public:
    void enqueue(const std::string& elem);
    std::string extractMin();
    const std::string& peek();
    static PQueue *merge(PQueue *one, PQueue *two);
private:
    // implementation dependent member variables and helper methods
};
```

enqueue is used to insert a new element to the priority queue. **extractMin** returns the value of highest priority (i.e., lexicographically smallest) element in the queue and removes it. **merge** destructively unifies the supplied queues and returns their union as a new priority queue. For detailed descriptions of how these methods behave, see the **pqueue.h** interface file included in the starter files.

Implementing the priority queue

While the external representation may give the illusion that we store everything in sorted order behind the scenes at all time, the truth is that we have a good amount of flexibility on what we choose as the **internal representation**. Sure, all of the operations need to work properly, and we want them to be fast. But we might optimize not for speed but for ease of implementation, or to minimize memory footprint. Maybe we optimize for one operation at the expense of others.

This assignment is all about client expectations, implementation and internal representation. You'll master arrays and linked lists in the process, but the takeaway point of the assignment—or the most important of the many takeaway points—is that you can use whatever machinery you deem appropriate to manage the internals of an abstraction.

You'll implement the priority queue in four different ways. Two are straightforward, but the third is nontrivial, and the fourth is very challenging (although so neat and clever and beautiful that it's worth the struggle).

- Implementation 1: Optimized for simplicity and for the **enqueue** method by backing your priority queue by an unsorted **Vector<string>**. **merge** is pretty straightforward, and **peek** and **extractMin** are expensive, but the expense might be worth it in cases where you need to get a version up and running really quickly for a prototype, or a proof of concept, or perhaps because you need to **enqueue** 50,000 elements and extract a mere 5. I don't provide much in terms of details on this one, as it's pretty simple.
- Implementation 2: Balance insertion and extraction times by implementing your priority queue in terms of a binary heap, discussed in detail below. When properly implemented, **peek** runs in $O(1)$ time, **enqueue** and **extractMin** each run in $O(\lg n)$ time, and **merge** runs in $O(n)$ time.
- Implementation 3: Optimized for simplicity and for the **extractMin** operation by maintaining a sorted doubly linked (**next** and **prev** pointers required) list of strings behind the scenes. **peek** and **extractMin** will run super fast, but **enqueue** will be slow, because it needs to walk the list from front to back to find the insertion point (and that takes time that's linear in the size of the priority queue itself). **merge** can (and should) be implemented to run in linear time, for much the same reason Merge from merge sort can be.
- Implementation 4: **enqueue**, **extractMin**, and **merge** all run in $O(\lg n)$, but only because we use a collection of binomial heaps behind the scenes. Binomial heaps are by far the most intense of the four data structures used in Assignment 5, so leave plenty of time ahead of the deadline to work on it.

Implementation 1: Unsorted Vector

This implementation is layered on top of our **Vector** class. **enqueue** simply appends the new element to the end. When it comes time to extract the highest priority element, it performs a linear search to find it. The implementation is straightforward as far as layered abstractions go and serves more as an introduction to the assignment architecture than it does as an interesting implementation. Do this one first.

Aside

As you implement each of the subclasses, you'll leave **pqueue.h** and **pqueue.cpp** alone, and instead be modifying the interface (**.h**) and implementation (**.cpp**) files for each of the subclasses. In the case of the unsorted vector version, you'll be concerned with **pqueue-vector.h** and **pqueue-vector.cpp**. **pqueue-vector.h** defines the public interface you're implementing, but its **private** section is empty:

```
class VectorPQueue : public PQueue {
public:
    VectorPQueue();
    ~VectorPQueue();

    static VectorPQueue *merge(VectorPQueue *one, VectorPQueue *two);

    void enqueue(const std::string& elem);
    std::string extractMin();
    const std::string& peek();

private:
    // update the private section with the list of
    // data members and helper methods needed to implement
    // the vector-backed version of the PQueue.
};
```

Not surprisingly, the **private** section shouldn't be empty, but instead should list the items that comprise your internal representation. You should erase the provided comment and insert the collection of data members and private helper functions you need.

The **pqueue-vector.cpp** file provides dummy, placeholder implementations of everything, just so the project cleanly compiles. In a few cases, the dummy implementations sort of do the right thing, but a large majority of them need updates to include real code that does real stuff.

Important: the parent **PQueue** class defines a **protected** field called **logSize**, which means you have access to it. You should ensure that **logSize** is always maintained to house the logical size of the priority queue—both here and in the other three implementations. By unifying the **logSize** field to the parent class, we can implement **size** and **isEmpty** at the **PQueue** class level (I already did for you), and all subclasses just inherit it.

As you advance through the implementations, understand that you'll be modifying different pairs of interface and implementation files (**pqueue-heap.h** and **pqueue-heap.cpp** for the binary heap version, etc). In all cases, the **private** sections of the interface are empty and need to be fleshed out, and in all cases the implementation files have placeholder implementations to seduce the compiler into thinking everything is good.

Implementation 2: Binary Heap

Although the binary search trees we'll eventually discuss might make a good implementation of a priority queue, there is another type of binary tree that is an even better choice in this case.

A *heap* is a binary tree that has these two properties:

- It is a *complete* binary tree, i.e. one that is full in all levels (all nodes have two children), except for possibly the bottommost level, which is filled in from left to right with no gaps.
- The value of each node is less than or equal to the value of its children.

Here's a conceptual picture of a small heap of integer strings (i.e. strings where all characters are digits):

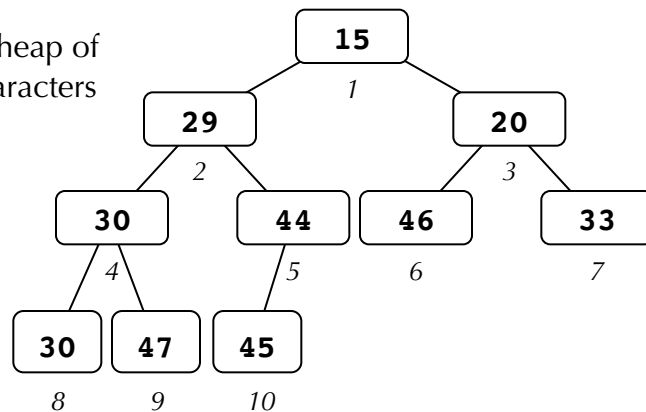

Note that a heap differs from a binary search tree in two significant ways. First, while a binary search tree keeps all the nodes in a sorted arrangement, a heap is ordered more loosely. Conveniently, the manner in which a heap is ordered is enough for the efficient performance of the standard priority queue operations. The second important difference is that while binary search trees come in many different shapes, a heap must be a complete binary tree, which means that every binary heap containing ten elements is the same shape as every other binary heap with ten elements.

Representing a heap using an array

One way to manage a heap would be to use a standard binary tree node definition and wire up **left** and **right** child pointers to sub-trees. However, we can and will exploit the completeness of the binary heap's tree and create a simple **array** representation and avoid the pointers.

Consider the nodes in the heap to be numbered level by level like this:

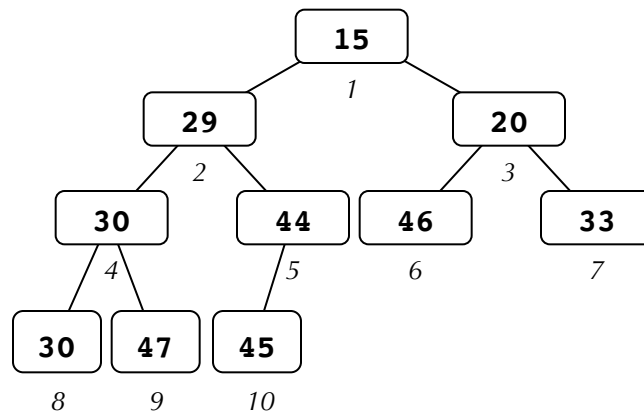

and check out this array representation of the same heap:

15	29	20	30	44	46	33	30	47	45
1	2	3	4	5	6	7	8	9	10

You can divide any node number by 2 (discarding the remainder) to get the node number of its parent (e.g., the parent of 9 is 4). The two children of node i are $2i$ and $2i + 1$, e.g. node 3's two children are 6 and 7. Although many of the drawings in this handout use a tree diagram for the heap, keep in mind you will actually be representing the binary heap with a dynamically allocated array, much like the **Vector** does.

Heap insert

A new element is added to the very bottom of the heap and it rises up to its proper place. Suppose, for example, we want to insert a "25". We add a new node at the bottom of the heap (the insertion position is equal to the size of the heap), as with:

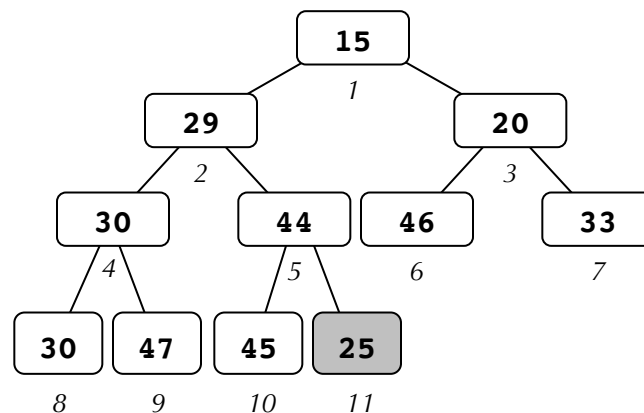

15	29	20	30	44	46	33	30	47	45	25
1	2	3	4	5	6	7	8	9	10	11

We compare the value in this new node with the value of its parent and, if necessary, exchange them. Since our heap is actually laid out in an array, we "exchange" the nodes by swapping array values. From there, we compare the ascended value to its new parent and continue moving the value up until it need go no further.

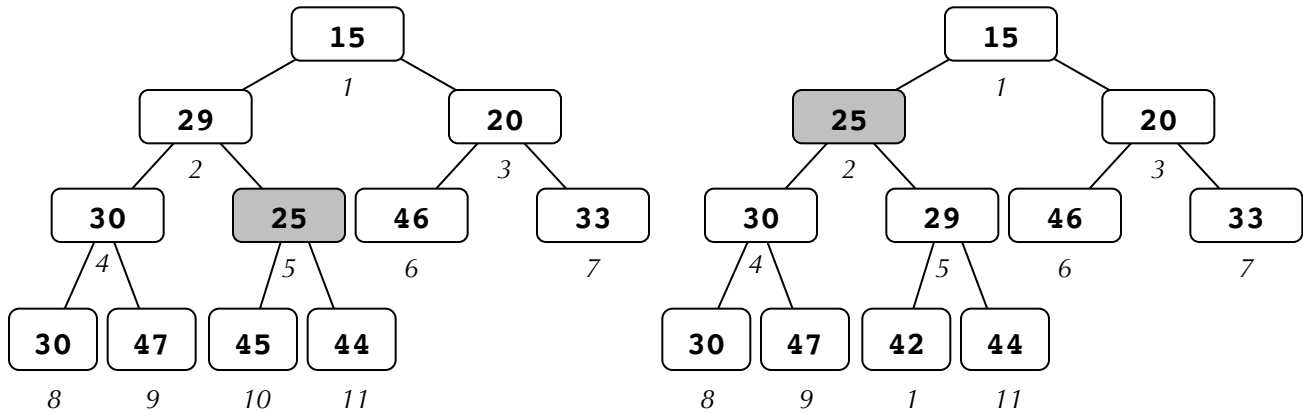

Heap remove

The binary heap property guarantees that the smallest value resides at the root, where it can be easily accessed. After removing this value, you typically need to rearrange those that remain. The completeness property dictates the shape of the heap, so it's the bottommost node that needs to be removed. Rather than re-arranging everything to fill in the gap left at the root, we leave the root node where it is, copy the **value** from the last node to the root, and remove the last node.

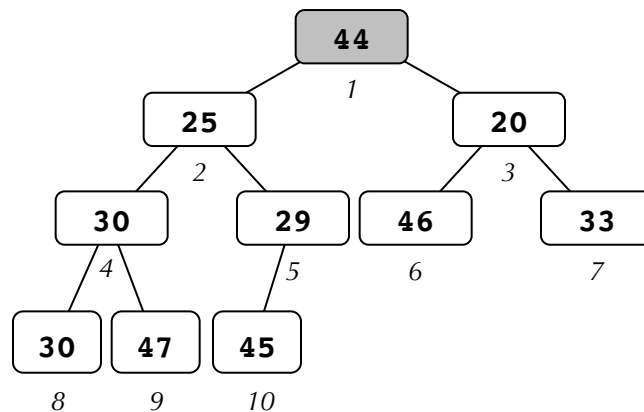

We still have a complete tree with one less value, and the left and right sub-trees are still legit binary heaps. The only potential problem: a violation of the heap ordering property, localized at the root. In order to restore the min-heap property, we need to trickle that value down to the right place. Start by comparing the value in the root to the values of its two children. If the root's value is larger than the values of either child, swap the value in the root with that of the smaller one:

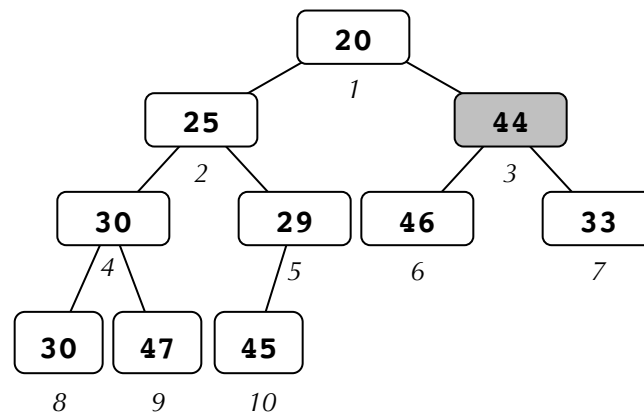

This step fixes the heap ordering property for the root node, but at the expense of the impacted sub-tree. The sub-tree is now another heap where its root node is out of order, so we can iteratively apply the same reordering on the sub-tree to fix it and any other impacted sub-trees.

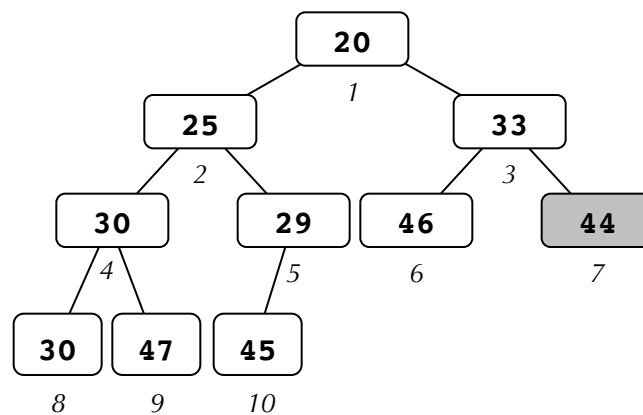

You stop trickling downwards when the value sinks to a level such that it is smaller than both of its children or it has no children at all. This bubble-down algorithm is often referred to as *heapify-ing*.

You should implement the priority queue as a binary heap array using the strategy outlined above. This array should start small (initially allocated space for 4 **strings**) and grow as needed.

Merging two heaps

The merge operation—that is, destroying two heaps and creating a new one that's the logical union of the two originals—can be accomplished via the same heapify operation discussed above. Yes, you could just insert elements from the second into the first, one at a time, until the second is depleted and the first has everything. But it's actually faster—*asymptotically so, in fact*—to do the following:

- Create an array that's the logical concatenation of the first heap's array and the second heap's array, without regard for the heap ordering property. The

result is a complete, array-backed binary tree that in all likelihood isn't even close to being a binary heap.

- Recognize that all of the leaf nodes—taken in isolation—respect the heap property.
- Heapify all sub-heaps rooted at the parents of all the leaves.
- Heapify all sub-heaps rooted at the grandparents of all the leaves.
- Continue to heapify increasingly higher ancestors until you reach the root, and heapify that as well.

Binary Heap Implementation Notes

Manage your own raw memory. It's tempting to just use a **Vector<string>** to manage the array of elements. But using a **Vector** introduces an extra layer of code in between your **HeapPQueue** and the memory that actually store the elements, and in practice, a core container class like the **HeapPQueue** would be implemented without that extra layer. Make it a point to implement your **HeapPQueue** in terms of raw, dynamically allocation arrays of **strings** instead of a **Vector<string>**.

Freeing memory. You are responsible for properly managing heap-allocated memory. Your implementation should not orphan any memory during its operations and the destructor should free everything it needs to.

Think before you code. The amount of code necessary to complete the implementation is not large, but you will find it requires a good amount of thought. It'll help to sketch things on paper and work through the boundary cases carefully before you write any code.

Test thoroughly. I know we've already said this, but it never hurts to repeat it a few times. You don't want to be surprised when our grading process finds a bunch of lurking problems that you didn't discover because of inadequate testing. The code you write has some complex interactions and it is essential that you take time to identify and test all the various cases. I've provided you with a minimal test harness to ensure that the **HeapPQueue** works in simple scenarios, but it's your job to play villain and try to break your implementation, knowing that you're done when you can't break it any longer.

Implementation 3: Sorted doubly linked list

The linked list implementation is a doubly linked list of values, where the values are kept in sorted order (i.e., smallest to largest) to facilitate finding and removing the smallest element quickly. Insertion is a little more work, but it's made easier because of the decision to maintain both **prev** and **next** pointers. **merge** is conceptually simple, although the implementation can be tricky for those just learning pointers and linked lists for the first time. This is the first linked structure you'll be writing for us, and you should review the textbook's implementation of the **Queue** and read over the **All About Linked Lists** handout beforehand.

Implementation 4: Binomial Heaps

The **binomial heap** expands on the idea of a binary heap by maintaining a collection of **binomial trees**, each of which respect a property very similar to the heap order property discussed for Implementation #2.

A binomial tree of order k (where k is a positive integer) is recursively defined:

- A binomial tree of order 0 is a single node with no children.
- A binomial tree of order k is a single node at the root with k children, indexed 0 through $k - 1$. The 0th child is a binomial tree of order 0, the 1st child is a binomial tree of order 1, ..., the m th child is a binomial tree of order m , and the $k - 1$ st child is a binomial tree of order $k - 1$.

Some binomial trees:

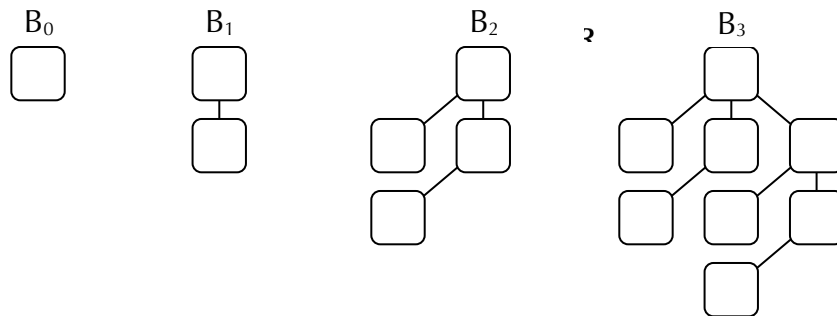

One property to note—and one that will certainly be exploited in the coming paragraphs, is that one can assemble a binomial tree of order $k + 1$ out of two order k trees by simply appending the root of the second to the end of the first root's sequence of children. A related property: each binomial tree of order k has a total of 2^k nodes.

A **binomial heap** of order k is a binomial tree of order k , where the heap property is recursively respected throughout—that is, the value in each node is lexicographically less than or equal to those held by its children. In a world where binomial trees store just numeric strings, the binomial tree on the left is also a binomial heap, whereas the one on the right is not (because the "55" is lexicographically greater than the "49"):

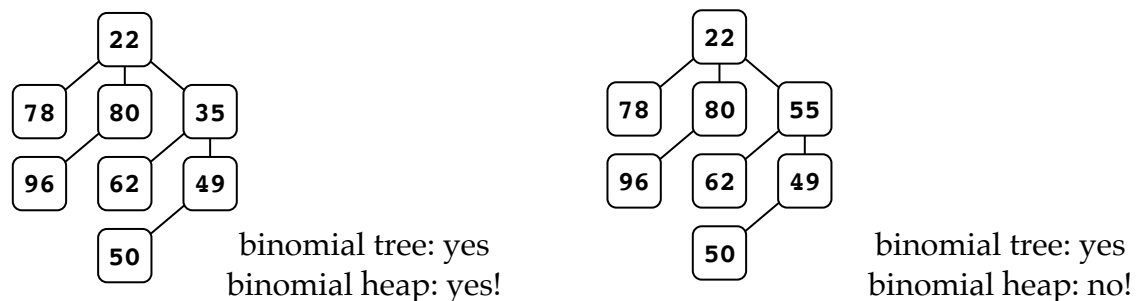

Now, if binary heaps can back priority queues, then so can binomial heaps. But the number of elements held by a priority queue can't be constrained to be some power of 2

all the time. So priority queues, when backed by binomial heaps, are really backed by a **Vector** of them.

If a priority queue needs to manage 11 elements, then it would hold on to three binomial heaps of orders 0, 1, and 3 to store the $2^0 + 2^1 + 2^3 = 1 + 2 + 8 = 11$ elements. The fact that the binary representation of 11_{10} is 1011_2 isn't a coincidence. The 1's in 1011 contribute 2^3 , 2^1 , and 2^0 to the overall number. Those three exponents tell us what binomial heap orders are needed to accommodate all 11 elements. Neat!

Binomial Heap Insert

What happens when we introduce a new element into the mix? More formally: What happens when you enqueue a new string into the **Vector<node *>**-backed priority queue? Let's see what happens when we enqueue a "20".

The size of the priority queue goes from 11 to 12—or rather, from 1011_2 to 1100_2 . We'll understand how to add this new element, all the time maintaining the heap ordering property within each binomial tree, if we emulate binary addition as closely as possible. That emulation begins by creating binomial tree of order 0 around the new element—a "20" in this example—and align it with the 0th order entry of the **Vector<node *>**.

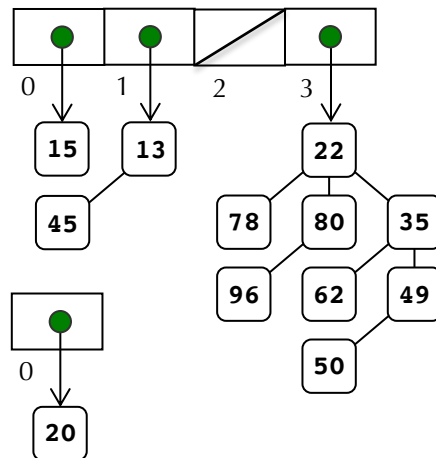

Now, when we add 1 and 1 in binary, we get 0, and carry a 1, right? We do the same thing when merging two order-0 binomial heaps, order-0 plus order-0 equal **NULL**, carry the order-1. One key difference: when you merge two order-0 heaps into the order-1 that gets carried, you need to make sure the heap property is respected by the merge. Since the 15 is smaller than the 20, that means the 15 gets an order-0 as a child, and that 15 becomes the root of the order-1.

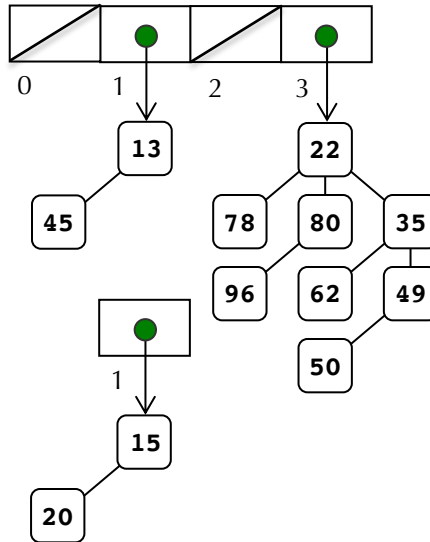

The carry now contributes to the merging at the order-1 level. The carry (with the 15 and the 20) and the original order-1 contribution (the one with the 13 and the 45) similarly merge to produce a **NULL** order-1 with an order-2 carry.

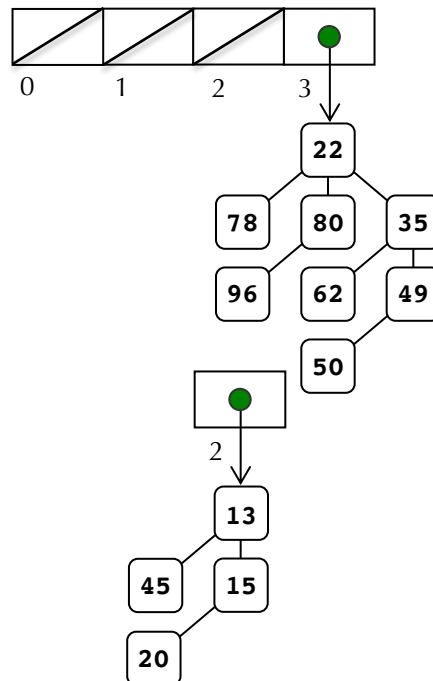

Had there been an order-2 in the original figure, the cascade of merges would have continued. But because there's no order-2 binomial heap in the original, the order-2 carry can assume that position in the collection and the cascade can end. In our example, the original binomial heap collection would be transformed into:

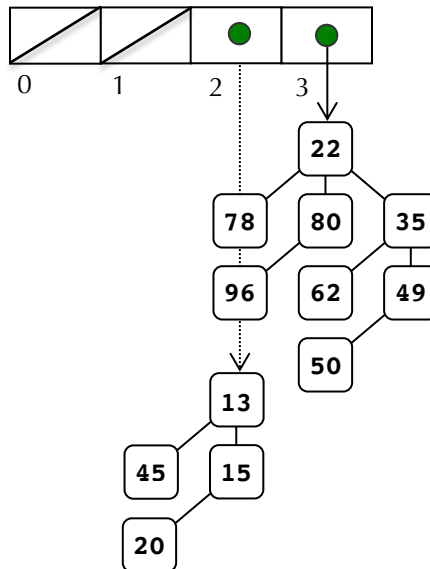

Binomial Heap Merge

The primary perk the binomial heap has over the more standard binary heap is that it, if properly implemented, supports merge much more quickly. In fact, two binomial heaps as described above can be merged in $O(\lg n)$ time, where n is the size of the larger binomial heap.

You can merge two heaps using an extension of the binary addition emulated while discussing **enqueue**. As it turns out, enqueueing a single node is really the same as merging an arbitrarily large binomial heap with a binomial heap of size 1. The generic merge problem is concerned with the unification of two binomial heaps of arbitrary sizes. So, for the purposes of illustration, assuming we want to merge two binomial heaps of size 13 and 23, represented below:

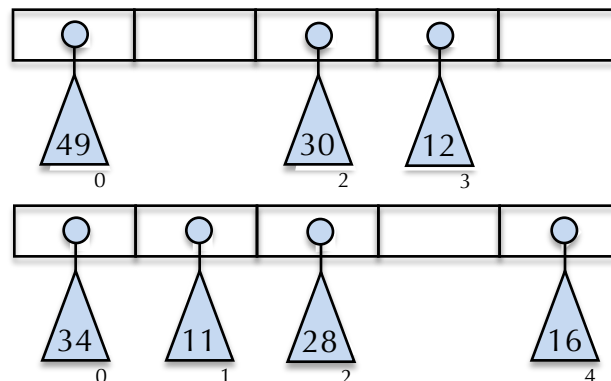

The triangles represent binomial trees respecting the heap ordering properties, and the subscripts represent their order. The numbers within the triangles are the root values—the smallest in the tree, and the blanks represent **NULL**. (We don't have space for the more elaborate pictures used to illustrate **enqueue**, so I'm going with more skeletal pictures.)

To merge is to emulate binary arithmetic, understanding that the 0s and 1s of pure binary math have been upgraded to be **NULLS** and binomial tree root addresses. The merge begins with any order-0 trees, and then ripples from low to high order—left to right in the diagram. This particular merge (which pictorially merges the second into the first) can be animated play-by-play as:

1. Merge the two order-0 trees to produce an order-1 (with 34 at the root) that carries.

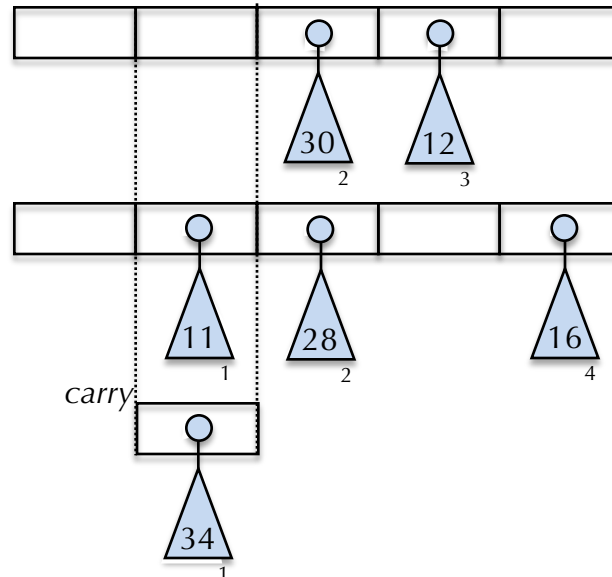

2. Merge the two order-1 trees to produce an order-2 tree carry, with 11 at the root.

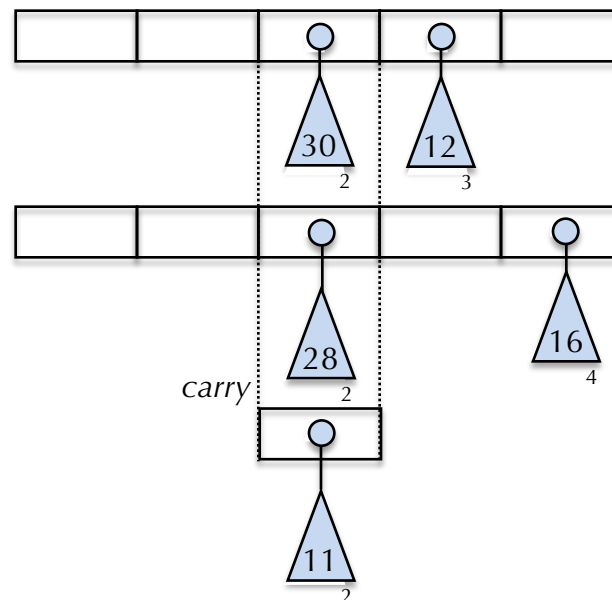

3. Merge the three (three!) order-2 trees! Leave one of the three alone (we'll leave the 11 in place, though it could have been any of the three) and merge the other two to produce an order-3 (with the smaller of 28 and 30 as the root).

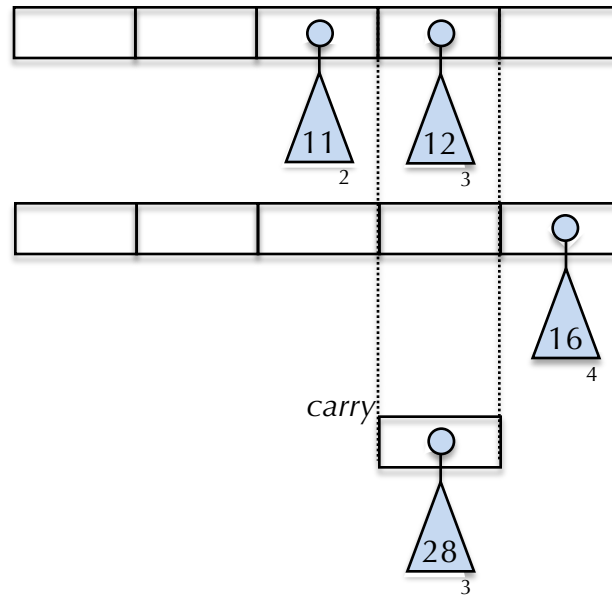

4. Merge the two order-3 trees to produce an order-4 tree carry, with 12 as the root:

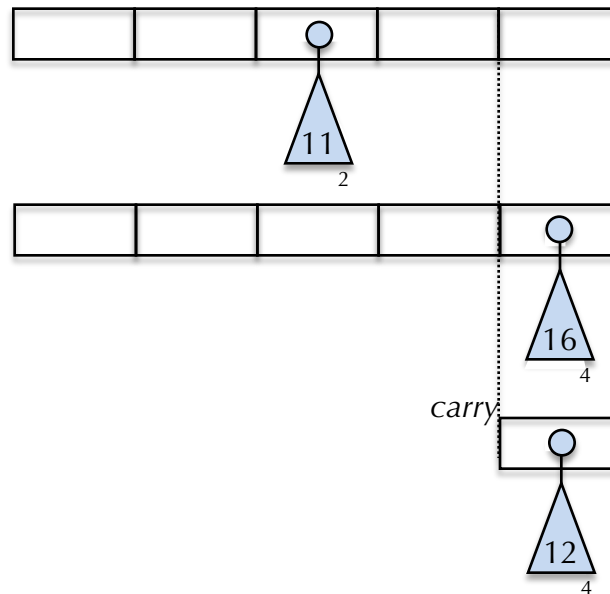

5. Finally, merge the two order-4s to materialize an order-5 tree with the 12 at the root. Because this is clearly the last merge, we'll draw just one final picture.

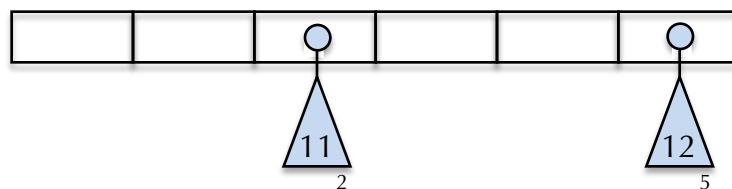

The above reflects the fact that the merged product should have $13 + 23$ equals 36_{10} equals 100100_2 elements, and it indeed does: The order-2 tree houses 4 elements, and the order-5 houses 32.

Binomial Heap Peek and **extractMin**

peek can be implemented as a simple **for** loop over all of the binomial heaps in the collection, and returning the smallest of all of the root elements it encounters (and it runs in $O(\lg n)$ time). **extractMin** runs like **peek** does, except that it physically removes the smallest element before returning it. Of course, the binomial heap that houses the smallest element must make sure all of its children are properly reincorporated into the data structure without being orphaned. Each of those children can be merged into the remaining structure in much the same way a second binomial heap is, as illustrated above.

Binomial Heap Implementation Notes

Think before you code. We said the same thing about the binary heap, but it's even more important here. You can't fake an understanding of binomial heaps and start typing, hoping it'll all just work out. You'll only succeed if you have a crystal clear picture of how **enqueue**, **merge**, and **extractMin** all work, and you write code that's consistent with that understanding. In particular, you absolutely must understand the general merge operation described above before you tackle any operations that update the binomial heap itself.

Use a combination of built-ins and custom structures. Each node in a binomial heap should be modeled using a data structure that looks something like this:

```
struct node {
    string elem;
    Vector<node *> children;
};
```

As opposed to the binary heap, the binomial heap is complicated enough that you'll want to rely on sensibly chosen built-ins and layer on top of those. You're encouraged to use the above node type for your implementation, and only deviate from it if you have a compelling reason to do so.

Freeing memory. You are responsible for freeing heap-allocated memory. Your implementation should not orphan any memory during its operations and the destructor should free all of the internal memory for the object.

Accessing files

We've assembled a Qt Creator project for you already, and that project encapsulates many interface (**.h**) and implementation (**.cpp**) files.

pqueue-test.cpp	Test harness to assist in development and testing.
pqueue	Interface and partial implementation of base PQueue class. The primary purpose of the PQueue class is to define the interface that all concrete priority queue implementations should agree on.
pqueue-vector	Interface and implementation file housing the unsorted vector version of the priority queue.
pqueue-heap	Interface and implementation file housing the version of the priority queue that's backed by the array-packed binary heap.
pqueue-linked-list	Interface and implementation file housing the sorted, doubly linked list version of the priority queue.
pqueue-binomial-heap	Interface and implementation file housing the version of the priority queue that's backed by binomial heaps.